

U | QUARTZ

FABRICATION MANUAL



HEALTH AND SAFETY GUIDELINES

While handling, fabricating or installing always comply with local health and safety law and regulations.

Follow the manuals and instructions of manufacturers of the tools and equipment you use. Keep them maintained in top condition.

During storage, handling and lifting the slabs keep a safe distance.

Always keep slabs secured during storage, handling and transportation.

Use your personal protective equipment. Safety glasses, proper gloves and safety shoes shall be worn all the times. Safety ear plugs are required in the fabrication shop or during fabrication at job sites.

U-Quartz dust contains silica which may cause heavy irritation and harm to respiratory tract, nose, throat and lungs. Never dry cut, shape or polish. Always use wet tools to reduce airborne particles. During processing always wear a dust mask and provide sufficient ventilation in the work place.

U | QUARTZ

STORAGE AND HANDLING OF SLABS

U-Quartz slabs are best loaded/unloaded with forklifts or overhead cranes equipped with special attachments, clamps or straps. Always comply with manufacturers instructions and related regulations. Make sure that forklifts and cranes are properly maintained, and operated by trained staff only.

Handle slabs either singularly or in multiples of two. Multiple slabs have to be handled face to face or back to back.

Slabs must be stored in a way to prevent warpage. A-frames or slab racks are the best tools for storage. Improper racks or storage may cause warping in slabs.

Slabs must be stocked with a 7°-15° angle in vertical.

For short term storage, which does not exceed one week, slabs must be supported by minimum two beams with 150 cm height and at a distance of 180 cm apart. Slabs must be centrally placed on racks to have equal distance from beams to edges on both sides.

(DRAWING 1): A-FRAME AND STORAGE RACKS

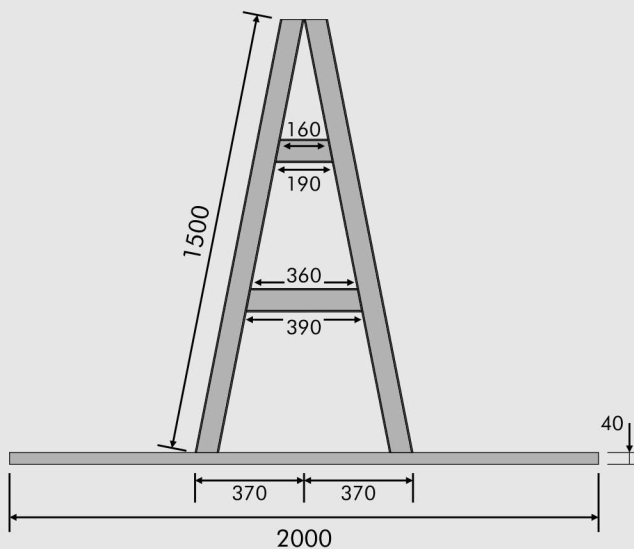

A-Frame Side View

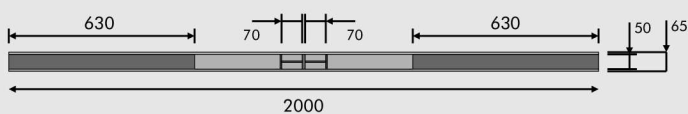

A-Frame Top View

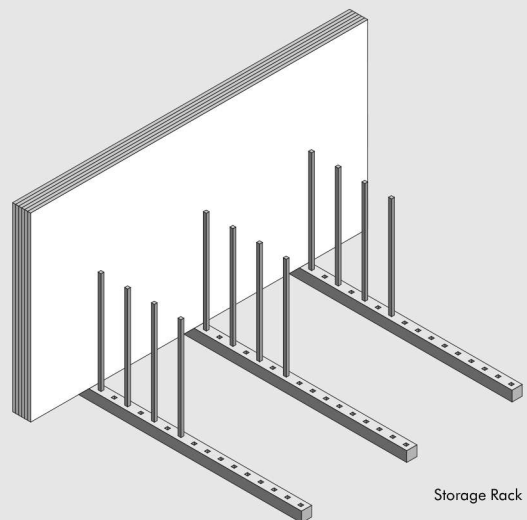

Storage Rack

All dimensions are in millimeters (mm)

Long term storage, exceeding one week, must be on racks that support the slabs minimum at three spots, preferably in vertical and in horizontal. Ideal rack drawing is provided below.

Store the slabs face to face, with no gap in between.

Do not stack more than 20 slabs in 2 cm or 15 slabs in 3 cm on top of each other.

Storage must be done in a closed area or shade to protect slabs from dust, rain or direct sunlight. Exposure to direct sunlight may cause discoloration or fading in slabs.

Storage temperature should not exceed 55° C.

A-frames are the best options for transportation of slabs. Place slabs vertically on A-frames, face to face and without gap in between. Use straps to secure slabs to the A-frame and to each other.

(DRAWING 2): FULL SUPPORT STORAGE RACKS

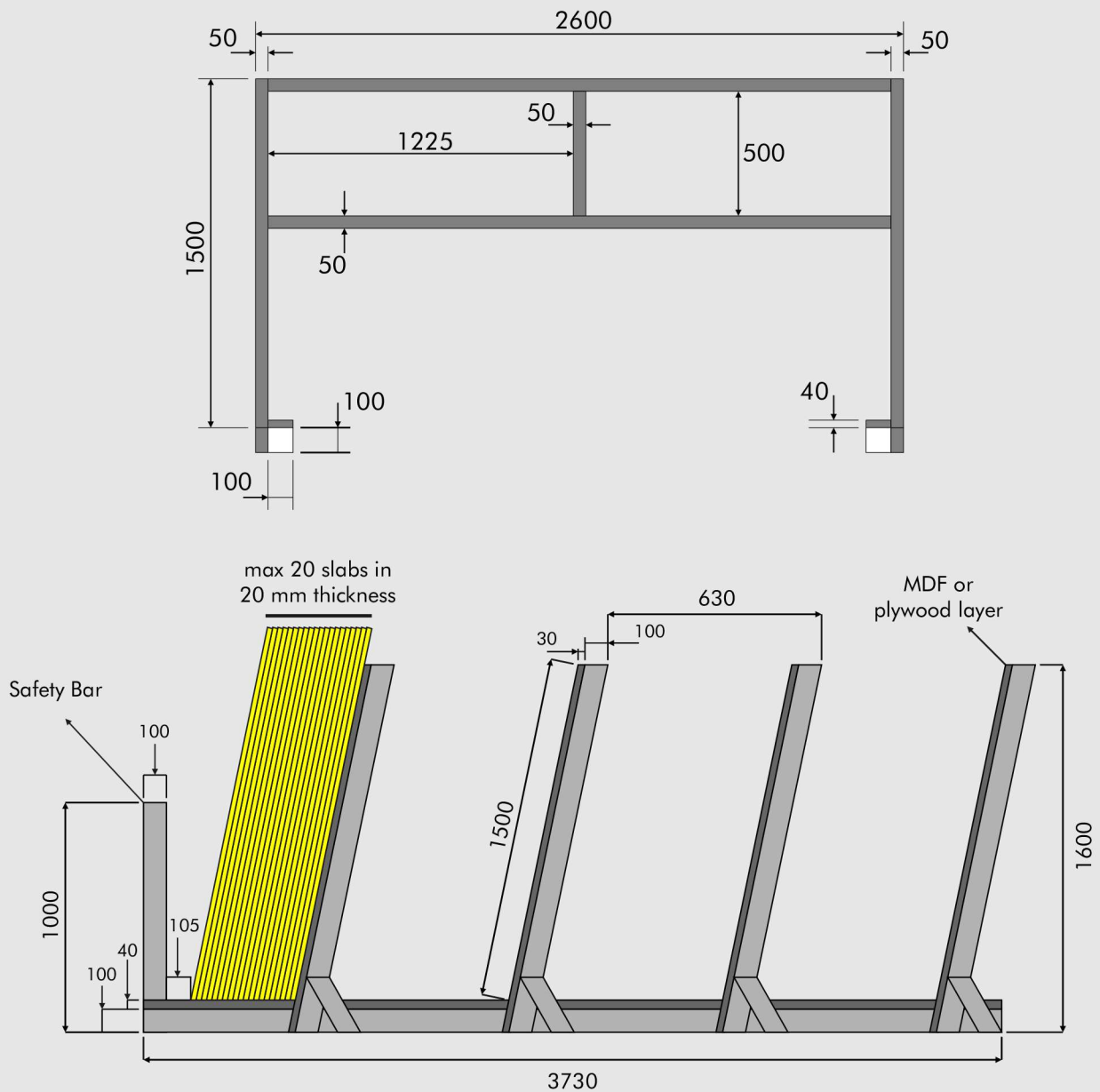

All dimensions are in millimeters (mm)

GENERAL PRINCIPLES

Although invisible, U-Quartz expands and shrinks with thermal change. Therefore, it needs to be applied with flexible adhesives. Polyester based adhesives must be used to glue U-Quartz pieces to each other, while 100% silicone-based adhesives must be preferred to glue U-Quartz to other materials. Rigid adhesives (such as cement based ones or natural stone adhesives) must never be used with U-Quartz.

Countertops must be strongly supported on cabinets. Where needed support strips with minimum 4 cm width must be used to provide sufficient support. These strips can be made of flexible but strong materials such as U-Quartz slabs or marine plywood. Strips made of rigid materials, i.e. marble or granite, will generate stress on U-Quartz countertops and may cause cracks.

At every point where countertop changes direction there should be a seam. Do not plan L shape countertops in one piece.

All chemicals that will be used together for fabrication and installation (such as polyester based adhesives, hardners and pigments) should be made by same manufacturer and recommended to be used together.

Inner corners (of holes, cutouts or inner corners of "L" or "U" shape countertops) must always be radiused. Always drill holes at the corners and then cut with perimeter intact at the corner. Do not cross cut holes, or perform square cuts. Square internal angles will generate stress points in slabs and may cause cracking.

To avoid overheating in slabs, drilling, cutting, grinding, polishing processes must be done with water cooled equipment and tools only.

Always use saw blades/ discs, core/drill bits, polishing pads made for or recommended by their manufacturers for processing quartz surfaces.

Do not try to change factory made surface on the slabs by re-polishing, sanding, grinding, honing, sealing. These processes will irreversibly harm the surface of the slab.

Do not use scorching pads, steel wool, detergents containing micro granules or chemicals with PH level higher than 8.5 or lower than 5 on U-Quartz surfaces.

Always use heat insulation layers between the countertop and under counter ovens, bain-maries, steam tables, coolers or similar heat radiating units.

(DRAWING 3): SUPPORT STRIPS

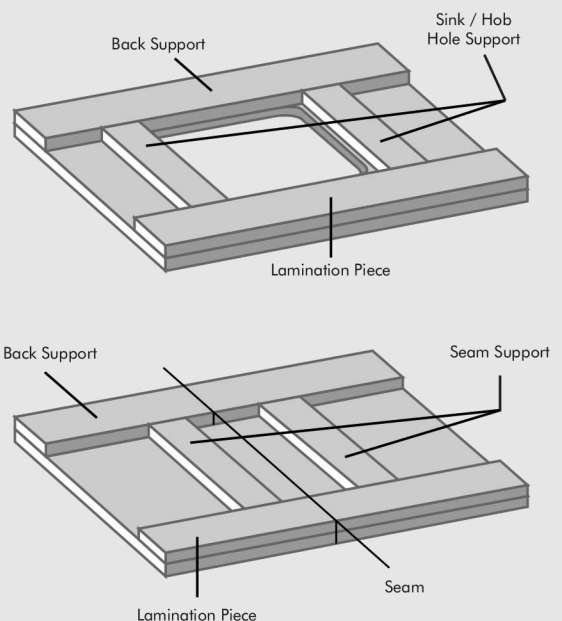

(DRAWING 4): INNER CORNER CUTTING DETAIL

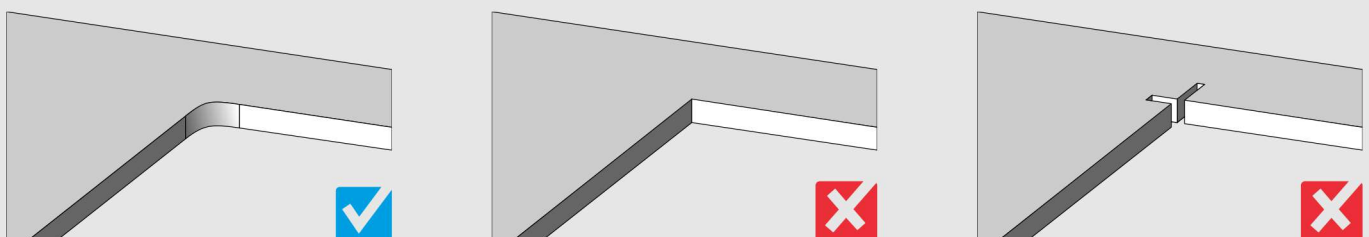

Decide for positions of sink and hob holes. Minimum distance between front and back edges of countertop and the holes must be 5 cm.

Minimum distance between sink/hob cutouts and seams must be 15 cm . If this is inevitable, place seams on cabinet frame and support with strips.

Always leave 4 mm thermal expansion gaps in all directions of sink and hob holes.

Avoid seam locations on dishwasher openings.

When you make your planning consider the access of the pieces to installation area.

(DRAWING 6): MINIMUM DISTANCES FOR SINK AND HOB CUTOUTS

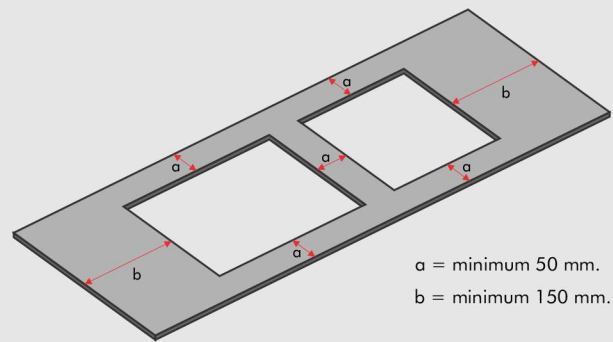

FABRICATION

Cutting

All cutting, grinding, polishing processes must be done only with wet tools. Use continuous plenty of water to cool the slab. Dry cutting and polishing generate excess heat which may damage structure of the slabs and cause hairline cracks, and also airborne silica dust.

Always use saw blades, discs, core/drill bits made for or recommended by their manufacturers for processing quartz surfaces. Use your tools in the speed and direction recommended by manufacturers. Always use sharp blades which are in good condition. Worn disks or missing teeth / segments will cause chipping and saw marks on edges. Such imperfections decrease edge and seam quality.

Your cutting table has to be flat to support the slab at all points. Bumps or gaps on the table negatively effect cutting quality, and may cause cracking during cutting. Weekly check the flatness of your cutting table with a minimum 3-meter straight edge, and immediately fix problems.

Start cutting with longer edge of the slab. Cutting should always start from the edges, never start cutting in the center of the slab.

L shape countertops should be cut in two pieces with a seam.

For inner corners first drill a hole at the corners with a radius. Avoid damaging the perimeter of the hole at the very corner with cutting disc. This radius at the corner is necessary to prevent stress. Cross cut corners with 90° angle may crack due to excess stress. Please refer to Drawing 9 for inner corners and minimum radiuses required.

L shape countertops composed of two pieces may be seamed straight or with 10 mm radius.

FABRICATION AND INSTALLATION

Inspection of Slabs and Planning

Remove the protective film on the surface of the slab. Clean the surface if necessary. Check the surface quality under sufficient light in different angles.

Slabs with different production dates may have shade differences. If you need multiple slabs for the job, always use slabs with **sequential barcodes**. In any case, check shade consistency of multiple slabs under the same lighting conditions and side by side.

U-Quartz slabs has a 1,2mm thickness tolerance. Check thickness consistency of multiple slabs you will seam together.

U-Quartz slabs have random granule and pattern distribution, which may cause variations within and between slabs. These variations are more visible in marble vein patterns. Consider possible variations for your planning.

Improper storage may cause warpage in slabs. Warped slabs may not set on cutting table properly. This may lower cutting quality or cracking during cutting. Warpage must be checked with a full length straight-edge when slab is horizontally placed on a fully supporting, strong and straight base.

Do not start cutting unless you confirm quality, sufficiency and consistency of slabs.

Measurement

Ensure that cabinets are securely set and affixed to each other and the wall behind.

Check if the tops of cabinets are flat and level. Substrates supporting the countertop should be level and flat within 1.0 mm in 3000 mm. Cabinets that are not flat will cause stress points in the countertop and may cause cracks.

For full backsplash installations also check if the walls between upper and lower cabinets are flat and plumb.

(DRAWING 5): THERMAL EXPANSION GAP

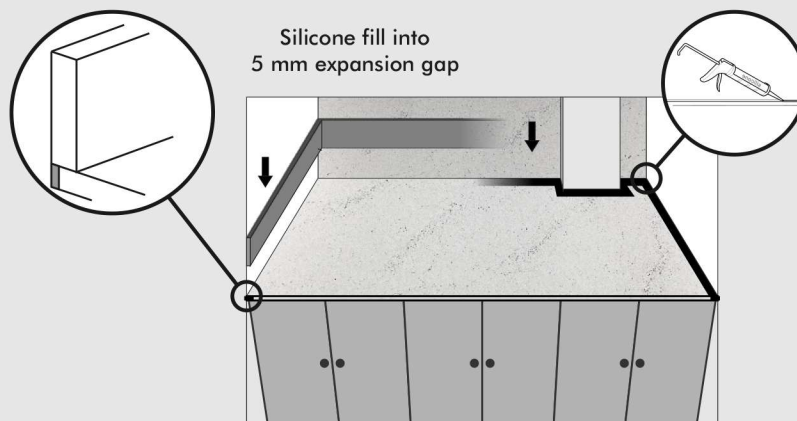

Leave 5 mm gap in all directions between the countertop and walls. This gap is necessary for thermal expansion.

(DRAWING 7): L SHAPE COUNTERTOPS

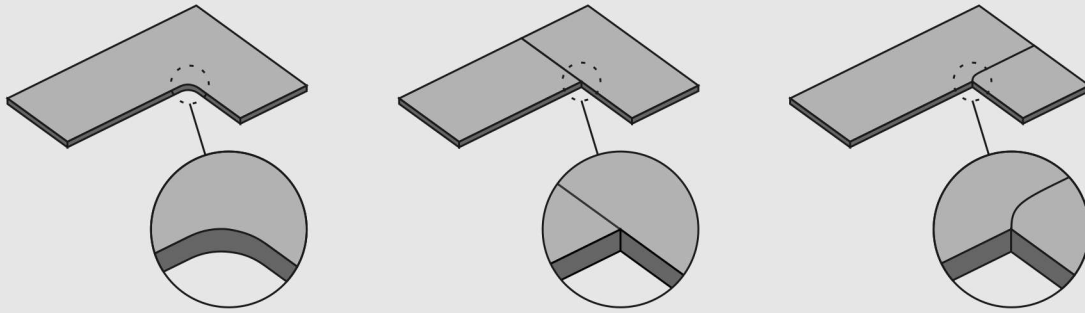

Sink / Hob Cutouts

Decide for layout of the cutout.

Drill 15 mm holes at the corners of hob cutouts, and 20 mm holes for sink cutouts. Perform straight cuts to connect the holes. Do not cross cut the hole with cutting disc. Inner radius of the hole must remain intact. This radius is necessary to prevent stress at the corners of cutouts. Cross cut corners with 90° angle may crack due to stress.

Leave 4 mm thermal expansion gap between the appliance and edge of the cutout. Support all edges of the cutout underneath with support strips made of U-Quartz or marine plywood. (Drawing 3)

Polish the edges of undermount sink cutouts as described on page 12. Do not leave the upper edges of cutouts square (with 90° angle). Square edges are prone to chipping due to impacts. Pencil round edges will be strong and aesthetic solutions.

Depth of grooves for flushed hobs and sinks must not exceed 8 mm.

(DRAWING 8): SINK AND HOB INSTALLATIONS

Top Mount Hob

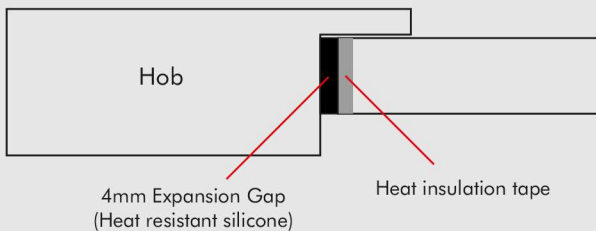

Flush Hob

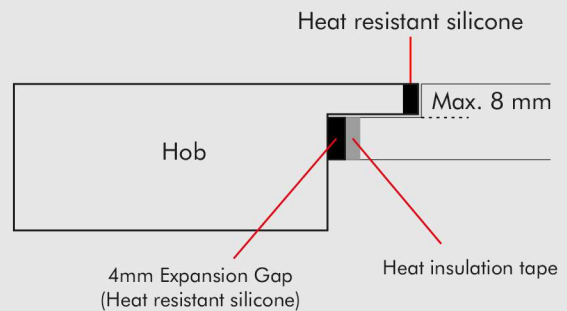

Top Mount Sink



Flush Sink

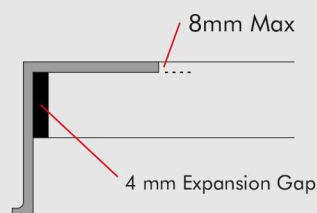

Undermount Sink

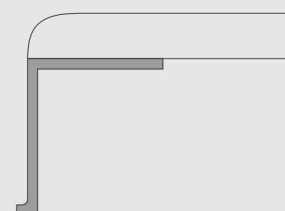

(DRAWING 9): INNER CORNERS AND MINIMUM RADIUS

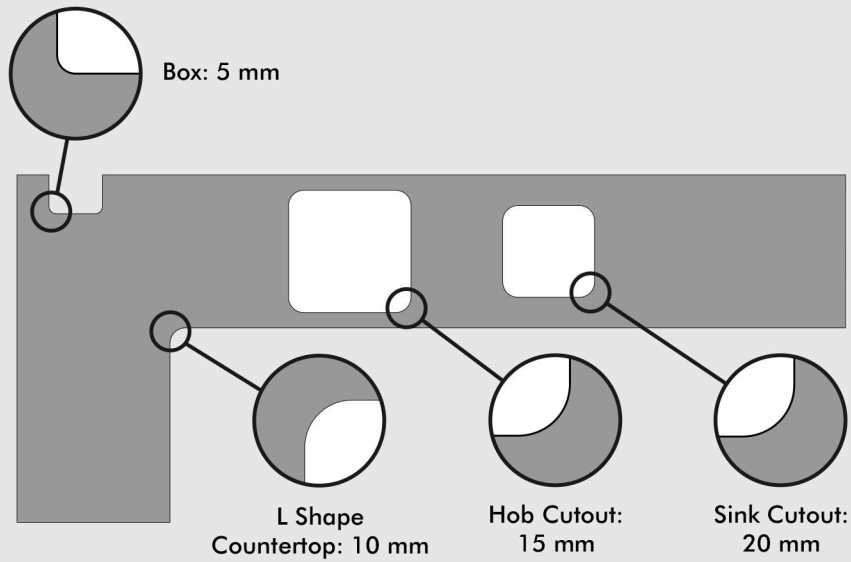

■ Lamination / Double Thickness

U-Quartz produces 20 and 30 mm thick slabs. Lamination is a method of building thicker edge profiles than the slab itself. Lamination is made by fixing stripes of the countertop material under the front edge of the countertop.

For best color and shade match, lamination pieces should be cut from the same slab with the countertop.

Use full length lamination pieces. If you need to make seams in lamination piece, always make 45° seams in order to reduce stress.

Seam lamination pieces with 45° mitered end cuts at the corners. 90° seam of lamination pieces cause stress points and may result cracking.

(DRAWING 10): LAMINATION PIECES

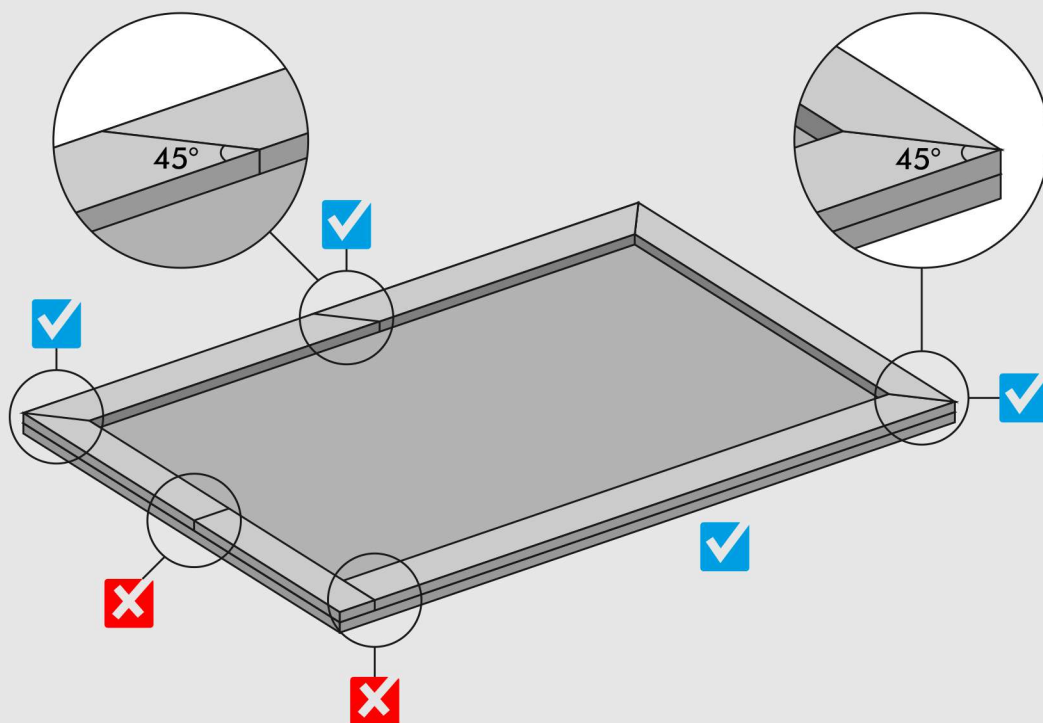

Smoothen the joint surfaces, clean dust and debris. Grind grooves on the joint surfaces to let more adhesive set between pieces.

Color the polyester adhesive to match the slab. Apply a layer of adhesive on entire surface of the joint.

Glue the pieces and clamp them every 10 cm. After the glue dries, you can clean and polish the edges.

■ Mitered Edges

Mitered edges are very aesthetic edge types that allow the pattern on the top of the countertop flow through the apron.

For perfect color and pattern match cut the countertop and the apron pieces from the same slab, preferably from adjacent areas.

Cut the pieces with 45° for maximum strength. Pieces must be perfectly parallel and joint surfaces must be clean and flush.

Upper edges of pieces are very weak and prone to chipping. Do not cut less than 45° angles as this will even make the pieces weaker and lower the seam quality.

Clean the joint surfaces from dust and debris. Grind grooves on the joint surfaces to allow more adhesive. Color the polyester adhesive to match the slab and thoroughly distribute on the entire joint surface. Fix the pieces till the adhesive dries and then clean and finish the edges.

For an aesthetic result, seam at the top of edge has to be as narrow as possible. As 90° square edges are prone to chipping, 2-3 mm beveled or 3 mm pencil round edges are best edge profile options.

(DRAWING 11): MITERED EDGE

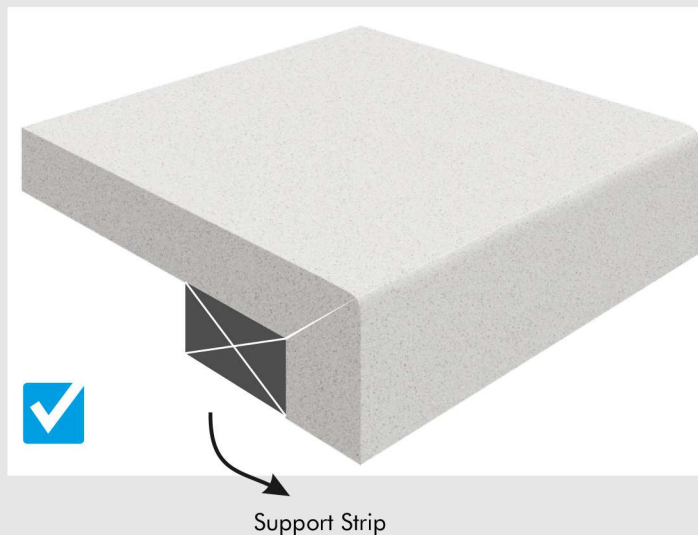

Edge Polishing

Prior to polishing, make sure that edges are clean, free of dust and debris.

For best result, use top quality tools and diamond peds, which are made for quartz surface processing.

Edge polishing must be done with wet tools only and with continuous supply of water. Dry polishing generates extreme heat on the slab, which undermines the physical structure of the slab, forms micro fissures, leading to chipping and discoloration where applied.

In order to reach requested polish level we recommend using quality diamond pads with below sequence:

Polished surfaces: 50, 100, 200, 400, 800, 1500, 3000 grits

Seams

Planning the seam locations is very important for an aesthetic and strong countertop, and efficient slab utilization.

Seams must be located on cabinet frame or must be fully supported by plywood on top of the cabinets. If this is not possible they must be supported with strips made of **U-Quartz** slabs or marine plywood on both sides.

Seams must not be located over dishwashers.

Minimum distance between cutouts and seams must be 15 cm. If a closer seam is inevitable, seam must be placed on cabinet frame and supported with strips.

Seam surfaces must be smooth and free of dust and debris. Grind grooves on the seam surfaces to allow more space for adhesive. Set the pieces and check level of the pieces and seam quality.

In order to adjust height of seaming pieces use wedges or spacer shims. Never grind, sand or polish surface of slabs at seams to level pieces.

INSTALLATION

Packing and Transportation of Countertop Pieces

Countertop sections are heavy, bulky and fragile.

Use a sturdy base for safe transportation of countertop pieces. A metal A-frame with both faces covered with plywood is a good option.

Place the pieces on the A-frame face to face or back to back, without gaps in between. Pieces should stand on rough edges and polished edges be at the top.

Secure pieces to each other and to the A frame with straps. Straps should be tight enough to prevent pieces move during transit, but at the same time should not be too tight to put excess load on fragile sections like cutouts.

Care should be taken to protect straps from sharp edges of pieces.

Use rags or a soft layer to protect surface of pieces from metals, back sides of other pieces or any object that may damage the surface.

Allocate sufficient number of workers to move pieces to the job site. Extra care should be taken to support fragile sections of pieces, such as sink / hob cutouts.

Preparing The Substrate

Make sure that cabinets are securely and strongly fixed to each other and the wall behind.

Cabinets and legs must be strong enough to support the countertop. Upper frame of cabinets must be flat, plumb and level to within 1.0 mm in 3000 mm.

Application surfaces must be dry, free from dust, debris and chemicals.

Always use heat insulation layers between the countertop and under counter ovens, bain-maries, steam tables, coolers or similar heat radiating units.

Installation

Leave 5 mm thermal expansion gap between the countertop and walls in all directions. This gap is necessary for thermal expansion. (Drawing 5)

Countertop must be supported front to back every 60 cm with cabinet frames and/or strips.

Seams, dishwasher or oven openings must also be supported with strips.

Place the sections in their positions and check the result. Make necessary adjustments to a levelled seam before gluing. Use colored polyester based adhesive to match the slab. Color the glue to match the slab. Apply the glue thoroughly on the seam surfaces. Use a professional seam setter to make the seam as narrow as possible and pieces perfectly levelled.

We recommend use of professional seam setting tools for a perfectly levelled and narrow seam.

Never polish, sand or grind seams to level pieces. Such practices will irreversibly harm the countertop.

Use 100% silicone to fix the countertop to substrate. Apply the silicone in dabs with 20-25 cm apart. Use more silicone at corners, seam locations or around cutouts.

Under no condition use rigid adhesives (such as concrete based or marble-granite adhesives) on or mechanical fasteners (such as nails, screws, bolts) into **U-Quartz** slabs.

Install sinks and hobs in accordance with manufacturer's instructions. All sink installations must be fully supported with support rails independent of the countertop. Sink / hob cutouts must be supported on all edges.

Use 100% silicone to provide insulation around sinks. Use heat resistant silicone and heat insulation tapes around hobs.

Do not apply sealers or impregnators on **U-Quartz** surfaces. Remove all residues adhesives with a soft rag or plastic putty knife. Clean the surface with acetone, isopropyl alcohol or ethanol and rinse thoroughly.

Countertops should be strongly supported over corner cabinets.

Countertops that are not set on cabinets on both sides (such as on the side of pantries) should be supported with strips that will be attached on the back wall and additional cabinet panels on the side.

If you need to drill faucet holes into the countertop, make sure that you leave enough material around the hole to provide strength.

Supporting Overhangs

Overhangs must be supported as below:

2 cm Thick Slabs	2 cm Thick Slabs (Supported With 1.5 cm Plywood)	3 cm Thick Slabs	Support Requirement
Less than 20 cm	Less than 30 cm	Less than 40 cm	No support needed
Between 20-40 cm	Between 30-50 cm	Between 40-60 cm	Metal brackets at 60 cm intervals
Bigger than 40 cm	Bigger than 50 cm	Bigger than 60 cm	Panels, posts, columns or legs at 60 cm intervals

Back Splashes

U-Quartz backsplashes are maintenance free, aesthetic applications that beautifully match the countertop with minimum joints. As they are installed by the same installation team on the same day, U-Quartz backsplashes may save time for home owners.

For color and shade match, cut countertop and backsplash from the same slab or use slabs with same batch number.

Walls must be flat and plumb, free from dust, debris and chemicals.

(DRAWING 12): HOB AND BACKSPLASH DISTANCES



U | QUARTZ

